



APEM

K RANGE AT A GLANCE

KR
rocker switch



KL
locking rocker switch



KG
Rocker switches



KI
Indicators



Connectors



**Mounting
panel units**



Hole plug



Removing Tool





APEM

KR Series



NEW DESIGN

KG series

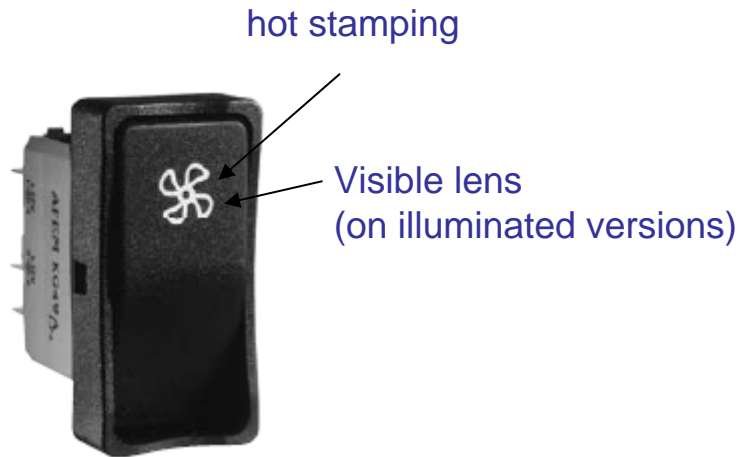

KR series



■ Marking process for illuminated versions

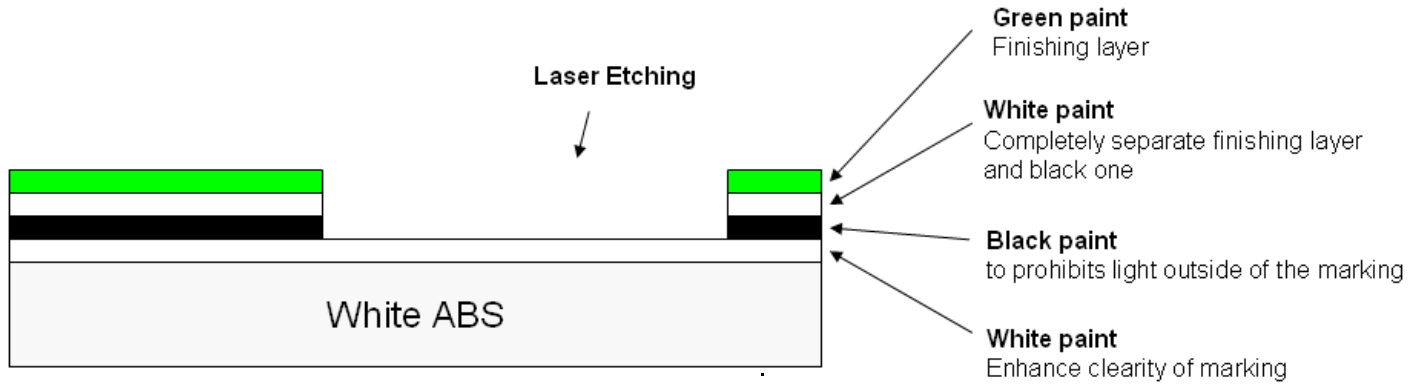

We will use ISO 7000

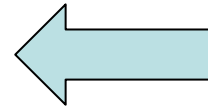

Available rocker colors



ENHANCED SPECIFICATIONS

KG series

■ Degree of protection
IP64

■ Approval
VDE approval on KG41 & KG46



■ Terminals

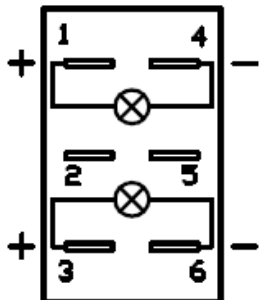

6 terminals
(Leds connected to the load)

KR series

■ Degree of protection
IP68

■ Approval
 2008
 UL1500 2008

■ With or Without Barrier
for use of jumpers

■ Terminals

6 terminals 10 terminals

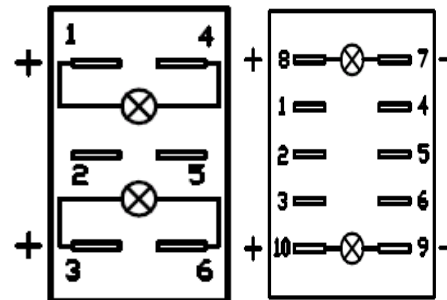

10 terminals
independent leds (→ variation)
or integrated illumination function

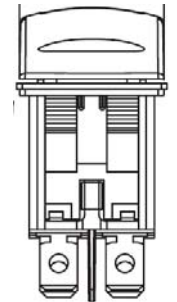

barrier

KR SERIES

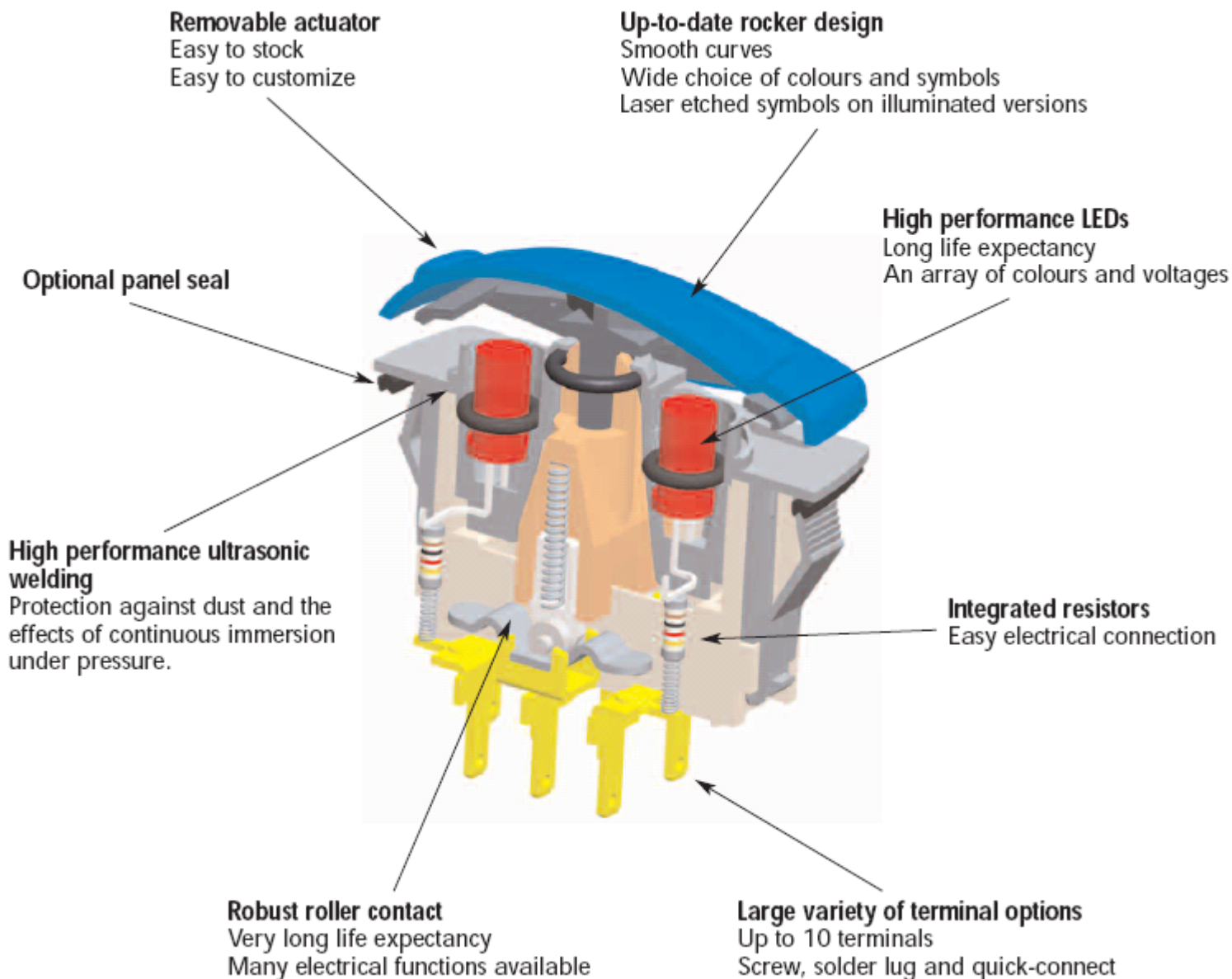

BROADER RANGE

■ Connector



For pre-cablings

■ Mounting panel



Mounting
Panel
end



Mounting
panel
middle

In order to limit the number of cut-out

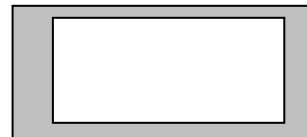

with

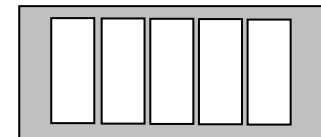

without



APEM

KG Series

WHICH PRODUCT TO CHOOSE : KG OR KR ?



The new KR series will progressively replace the KG series



The KG series will remain in some cases :

- for **replacement of a KG** in existing application
- to **prevent inadvertent actuation** of the rocker
- to **prevent debris** from being trapped under the actuator



APEM

KL Series



A P E M

KL SERIES

POWER ROCKER SWITCH – ONE LOCKED POSITION

Patented intuitive ergonomics
(USP compared with Carling)



non-illuminated symbol
only

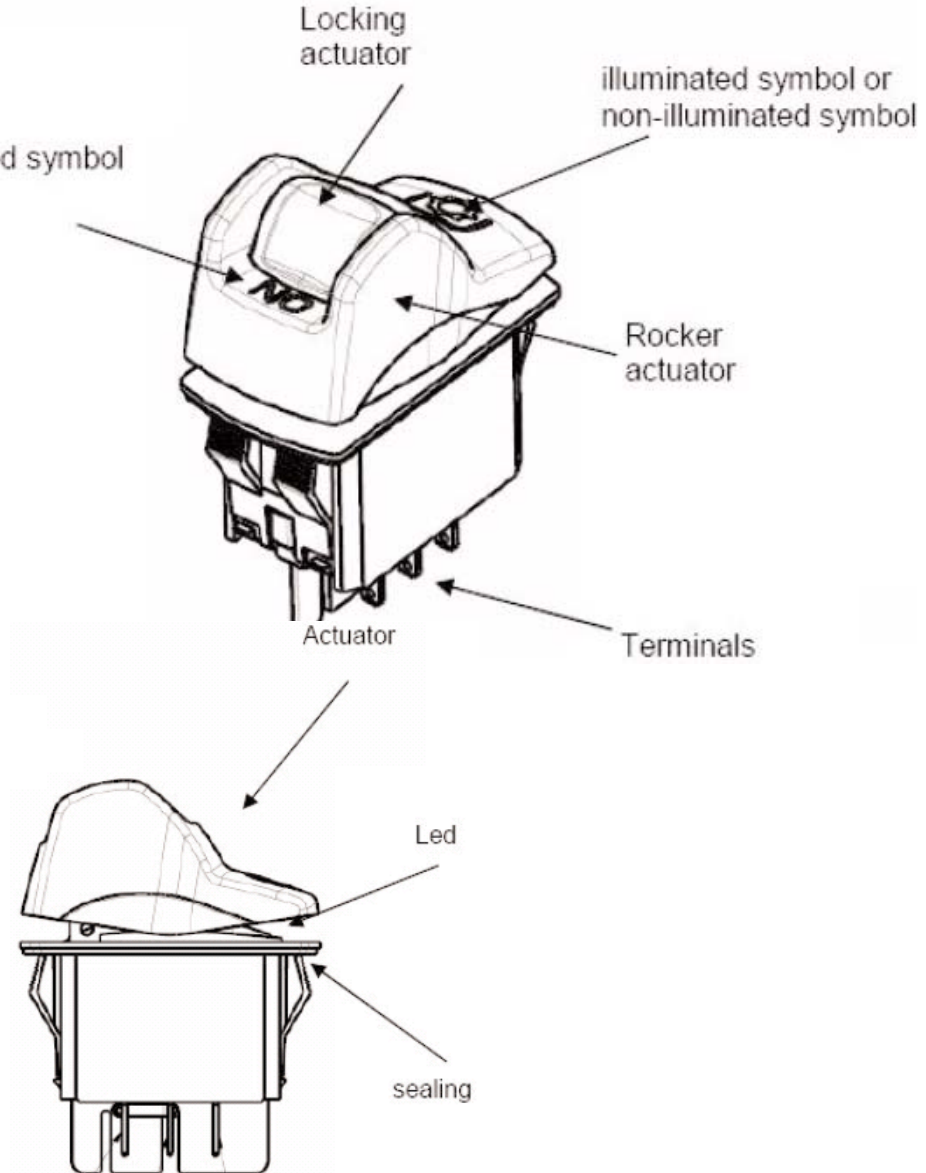

Different versions available:

- 3 positions
- 2 positions

always with only 1 locked position



APEM

Applications & Markets



Agricultural market

APPLICATIONS & MARKETS



Passenger vehicles
functions : all !



Public works, cleaning



powered garden cart (US)
(wheelbarrow)



Boats

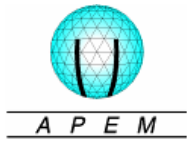

TARGET CUSTOMERS

- cockpit manufacturers
- dump truck manufacturers
- tractor manufacturers
- crane manufacturers
- commercial vehicle manufacturer
- boat manufacturers

**Our main marketing target : small & medium OEM's
(Carling is only servicing large OEM's)**

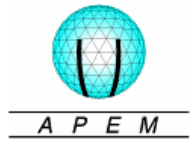

KEY SELLING POINTS

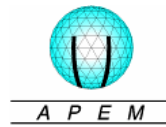
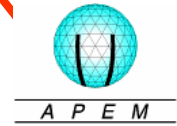
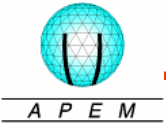

Just an example...

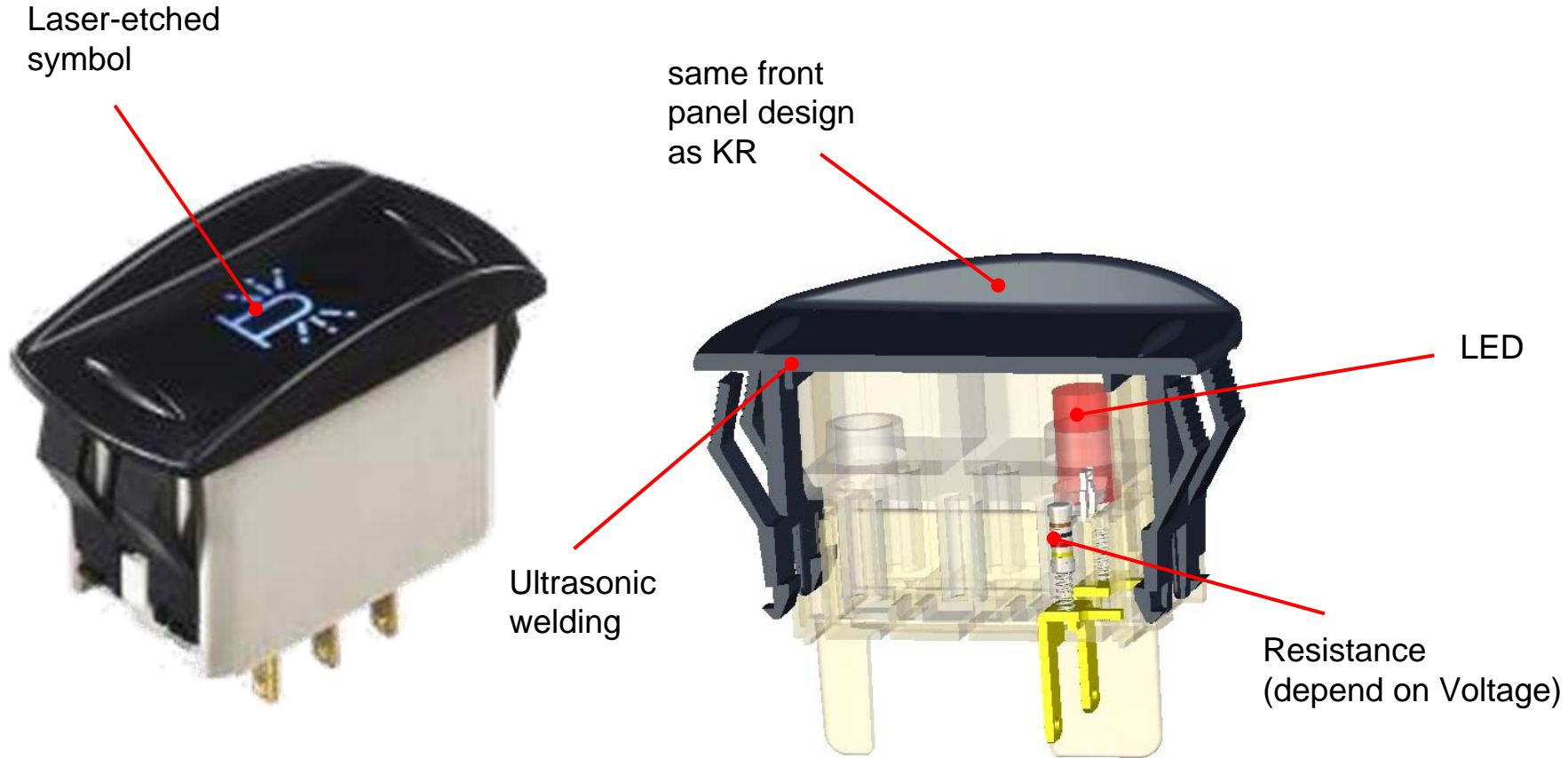

Project in-progress: KR-bus solution



Oct-08



Electrical
Vehicles



Busses



Power garden
carts





APEM

Products under development

KM



May-08

July-08

Sept-08

Oct-08

PBA extension range



Nov-08

Capacitive switch

Jan-09

AV project



IP69K

rugged pushbutton for outdoor applications

KS



KI



Extension to IP range IR series (Ø 16mm)

